

User Guide for RTQ2539C Low Dropout Linear Regulator Evaluation Board

General Description

The RTQ2539C is a high-current, ultra-low noise, ultra low-dropout (LDO) linear regulator. This document explains the function and use of the RTQ2539C evaluation board (EVB) and provides information for the setup and operating instructions, a schematic diagram, a printed circuit board (PCB) layout, and a bill of materials (BOM). For more detail information, please refer to the RTQ2539C datasheet.

Table of Contents

General Description	1
Performance Specification Summary	2
Power-up & Measurement Procedure	2
Detailed Description of Hardware	3
Bill of Materials.....	5
Typical Applications	6
Evaluation Board Layout.....	8
More Information.....	10
Important Notice for Richtek Evaluation Board.....	10

Performance Specification Summary

The RTQ2539C Evaluation Board (EVB) is a four-layer board measuring 50mm x 33.5mm with a copper thickness of 1oz, and the Table 1 is the summary of the EVB performance specification.

Table 1. RTQ2539C Evaluation Board Performance Specification Summary

Key Features	Test Conditions	Min	Typ	Max	Unit
Input Range					
Input Voltage		1.1	1.1	6.5	V
Enable Input Voltage		1.1	--	6.5	V
Output Range					
Output Voltage	Using external resistive voltage divider	0.5	0.5	5.5	V
Line Regulation	$I_{OUT} = 1\text{mA}$, $1.1\text{V} \leq V_{IN} \leq 6.5\text{V}$	--	0.05	--	%/V
Load Regulation	$1\text{mA} \leq I_{OUT} \leq 3\text{A}$	--	0.08	--	%/A
Dropout Voltage	$V_{IN} = 1.1\text{V to } 6.5\text{V}$, $I_{OUT} = 3\text{A}$, $V_{FB} = 0.5\text{V} - 3\%$	--	55	130	mV
Package					
WQFN-12L 2.2x2.5 (FC)					

Power-up & Measurement Procedure

Suggestion Required Equipments:

- RTQ2538H evaluation board
- DC power supply capable of at least 6.5V and 3A
- Electronic load capable of 3A
- Function generator
- Oscilloscope

Test Procedure with Suitable Measurement Equipment:

- Connect input power supply with wide and short as possible to VIN and GND through GP1/GP2 terminals.
- Connect the electronic load to VOUT and GND through GP3/GP4 terminals.
- Turn on the power supply and make sure that the input voltage does not exceeds 6V.
- Check output voltage regulation with different IOOUT for normal operation.

Notifications:

- Do not turn on input power supply before all connections are ready.
- Do not use the oscilloscope probe with long ground lead for output ripple voltage measurement, it is recommended to touch the probe tip and grounding directly across the last output capacitor.

Detailed Description of Hardware

Headers Description and Placement

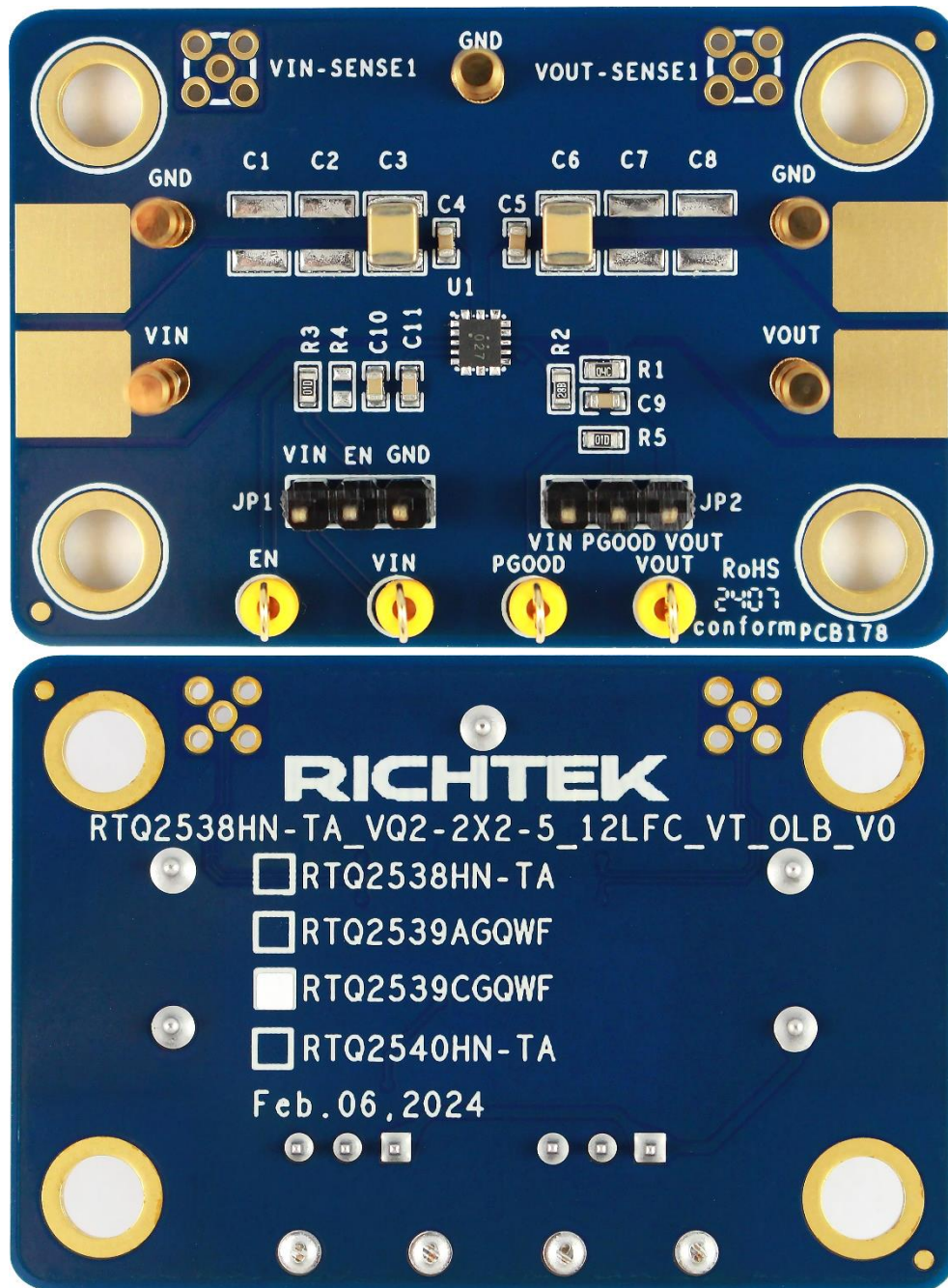

Carefully inspect all the components used in the EVB according to the following Bill of Materials table, and then make sure all the components are undamaged and correctly installed. If there is any missing or damaged component, which may occur during transportation, please contact our distributors or e-mail us at evb_service@richtek.com.

Test Points

The EVB is provided with the test points and pin names listed in the table below.

Test Point	Pin Name	Description
GP1	VIN	Positive terminal for supply input voltage.
GP2	GND	Negative terminal for supply input voltage.
GP3	VOUT	Positive terminal for output voltage.
GP4	GND	Negative terminal for output voltage.
GP5	GND	Reference ground test point.
TP1	VIN	For supply input voltage measurement.
TP2	EN	Enable voltage input pin.
TP3	PGOOD	For power good measurement.
TP4	VOUT	For output voltage measurement.
JP1	Enable	Connection for Enable voltage.
JP2	PGOOD	Connection for power good pu-ll high voltage.

Bill of Materials

Reference	Count	Part Number	Description	Package	Manufacturer
U1	1	RTQ2539CGQWF	Linear Regulator	WQFN-12L 2.2x2.5 (FC)	RICHTEK
C3, C6	2	1210X476K160CT	Capacitor, Ceramic, 47 μ F, 16V, X5R	C-1210	WALSIN
C4, C5	2	0603B104K500CT	Capacitor, Ceramic, 0.1 μ F, 50V, X7R	C-0603	WALSIN
C9, C11	2	0603B103K500CT	Capacitor, Ceramic, 10nF, 50V, X7R	C-0603	WALSIN
C10	1	0603B105K250CT	Capacitor, Ceramic, 1 μ F, 25V, X5R	C-0603	WALSIN
R1	1	WR06X1072FTL	Resistor, Chip, 10.7k, 1%	R-0603	WALSIN
R2	1	WR06X1911FTL	Resistor, Chip, 1.91k, 1%	R-0603	WALSIN
R3, R5	2	WR06X1003FTL	Resistor, Chip, 100k, 1%	R-0603	WALSIN

Typical Applications

EVB Schematic Diagram

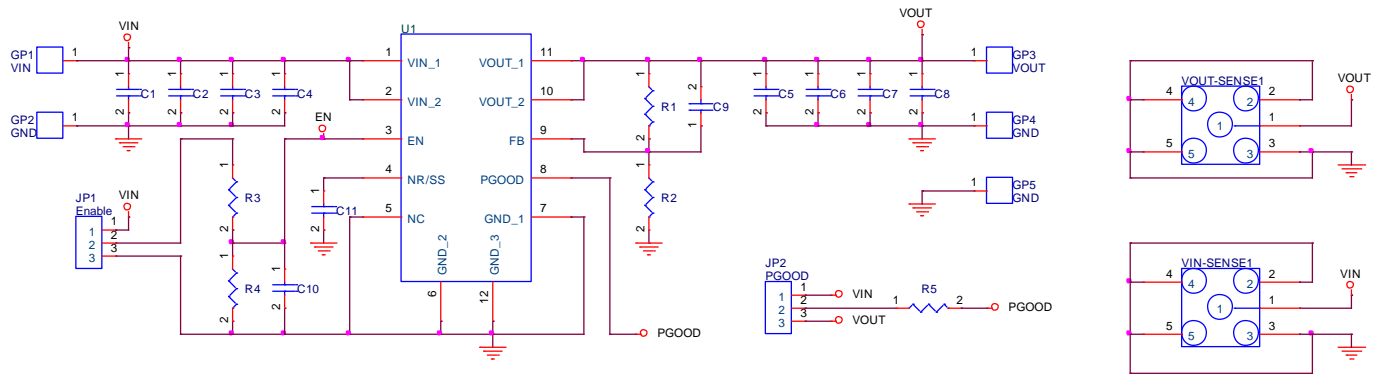

Measure Result

PSRR vs. Frequency and V_{OUT}

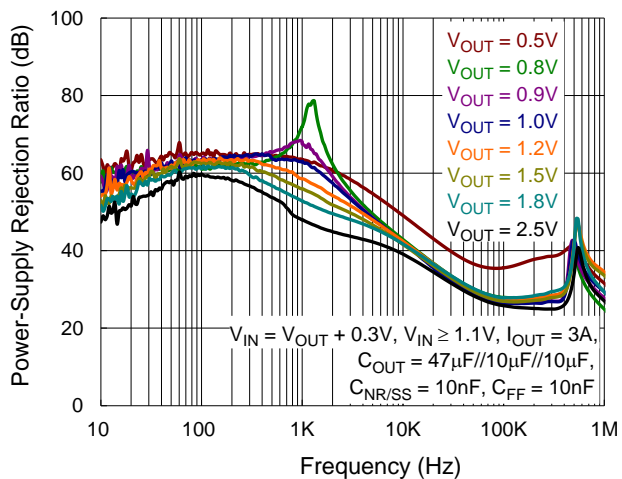

PSRR vs. Frequency and I_{OUT}

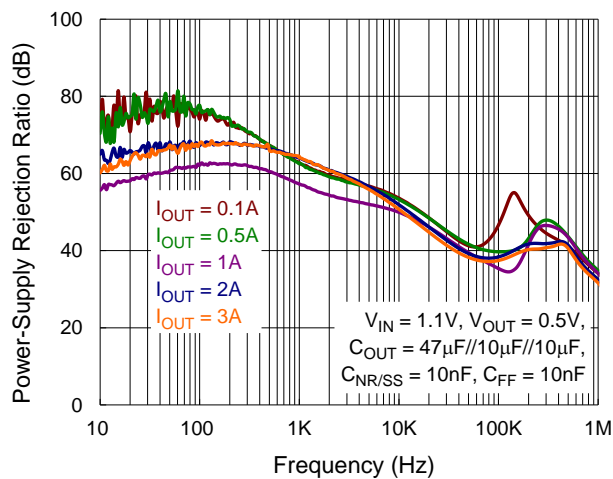

Output Noise vs. Frequency and V_{OUT}

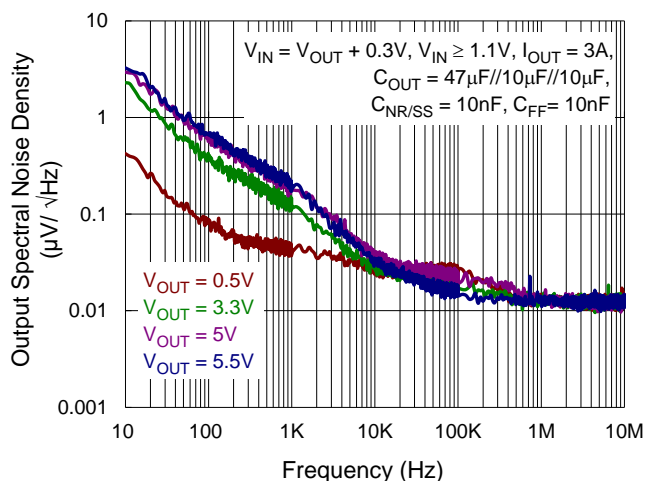

Output Noise vs. Frequency and C_{NR/SS}

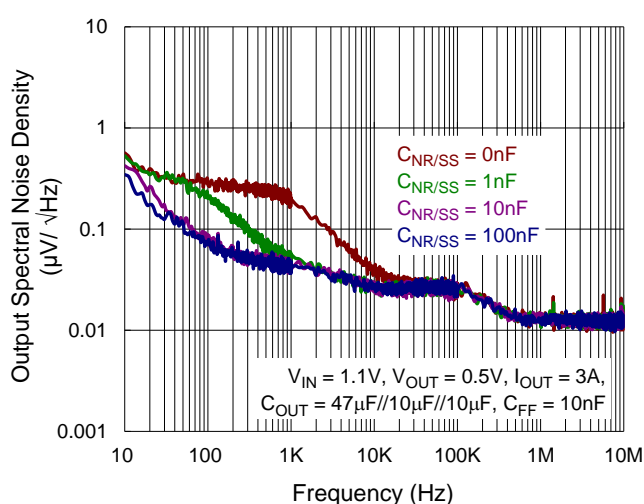

Power Up Response

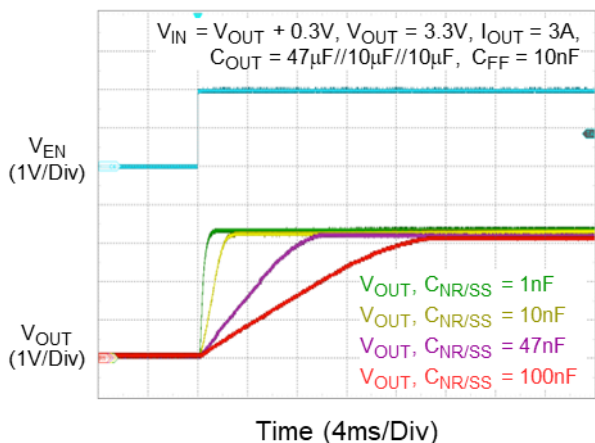

Load Transient Response

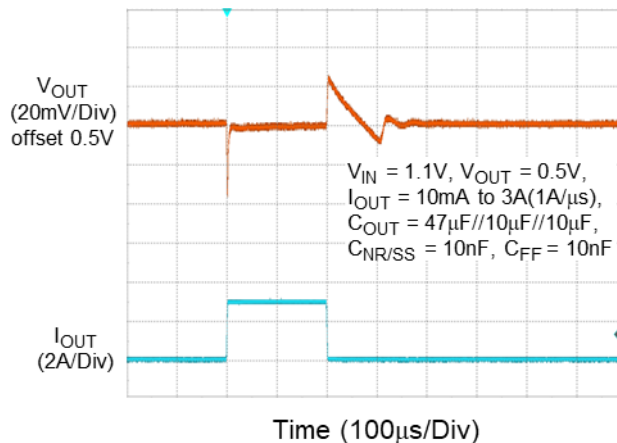

Evaluation Board Layout

Figure 1 to Figure 4 are the RTQ2539C evaluation board layout.

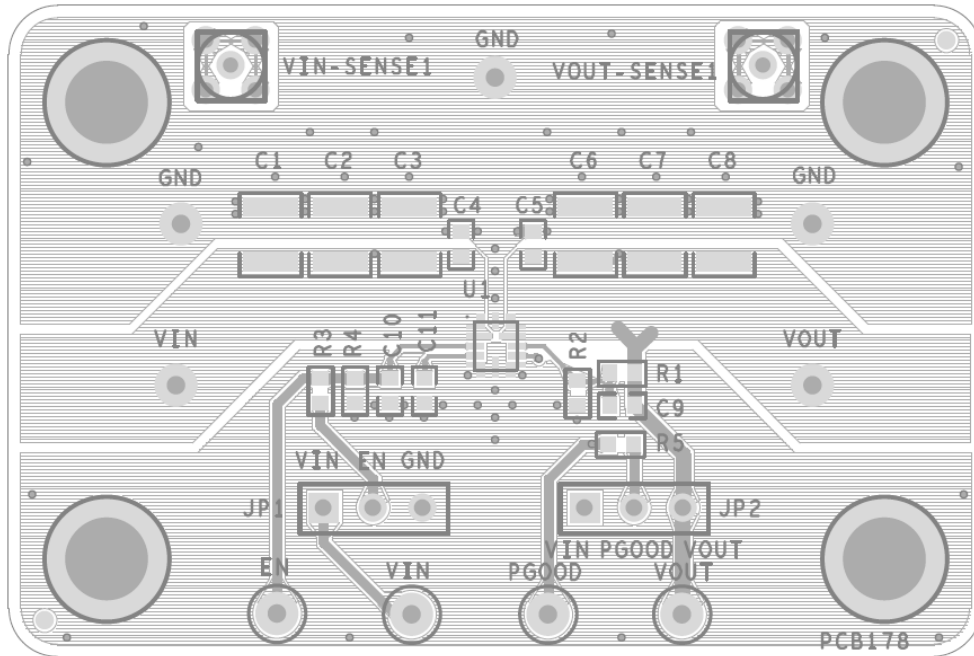

Figure 1. Top View (1st layer)

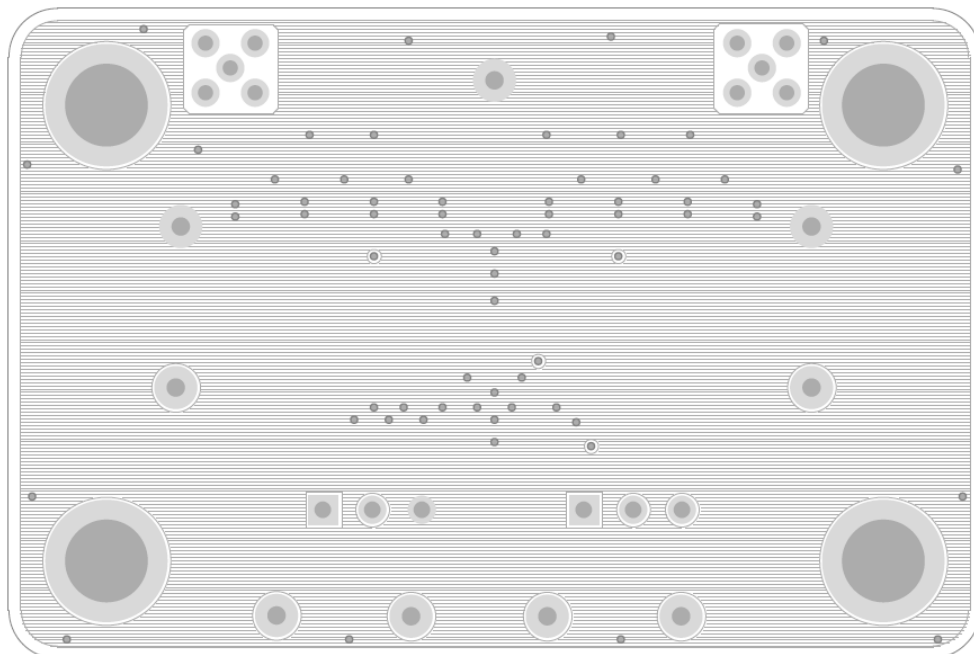

Figure 2. Inner Side (2nd Layer)

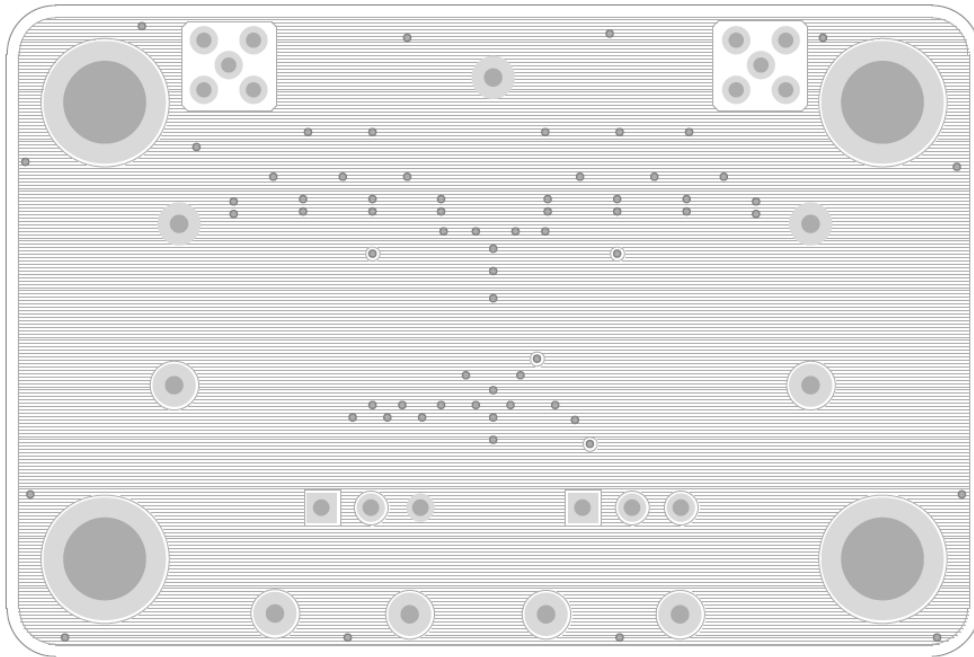

Figure 3. Inner Side (3rd Layer)

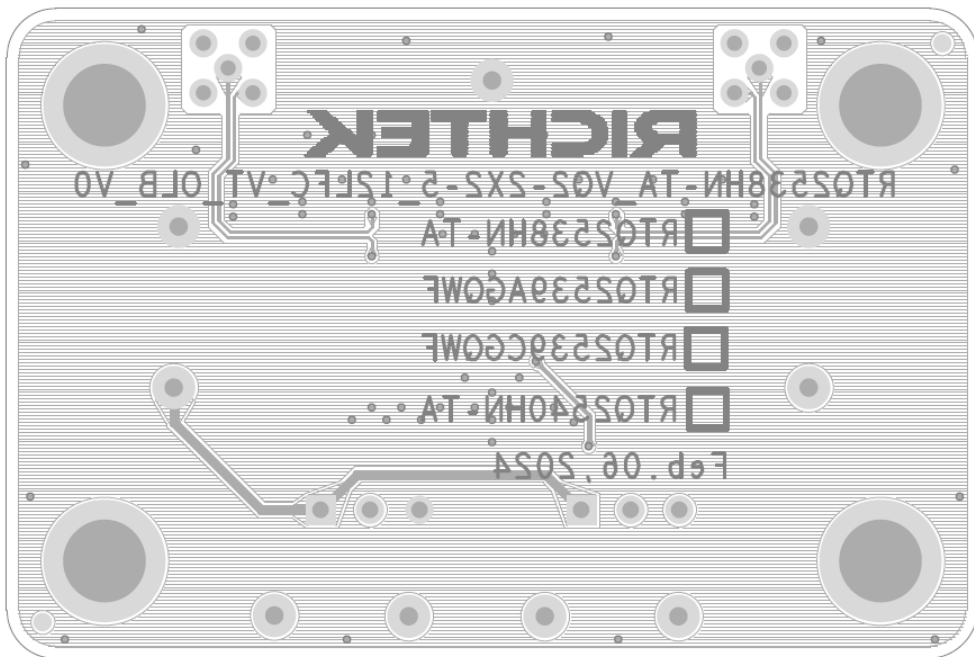

Figure 4. Bottom View (4th Layer)

More Information

For more information, please find the related datasheet or application notes from Richtek website

<http://www.richtek.com>.

Important Notice for Richtek Evaluation Board

THIS DOCUMENT IS FOR REFERENCE ONLY, NOTHING CONTAINED IN THIS DOCUMENT SHALL BE CONSTRUED AS RICHTEK'S WARRANTY, EXPRESS OR IMPLIED, UNDER CONTRACT, TORT OR STATUTORY, WITH RESPECT TO THE PRESENTATION HEREIN. IN NO EVENT SHALL RICHTEK BE LIABLE TO BUYER OR USER FOR ANY AND ALL DAMAGES INCLUDING WITHOUT LIMITATION TO DIRECT, INDIRECT, SPECIAL, PUNITIVE OR CONSEQUENTIAL DAMAGES.